

puris4life
spirit of bathrooms



Variado



Swing



Kera trendy



Cool line



elegance



Variādo

Ein absolut variables Plattenprogramm in nobler Optik und außergewöhnlichem Design. Perfekt darauf abgestimmt sind die modernen, beliebig kombinierbaren Schrankelemente sowie die Spiegel mit innovativer LED Technik (hohe Leuchtkraft, geringer Stromverbrauch). Variado zeigt Struktur mit „Ranura“! Diese stark geprägten Oberflächen in moderner Farbgebung tragen zum gefühlsbetonten Baderlebnis bei. Für Liebhaber der glatten Optik ist Hochglanz Weiß im Programm. Aufsatzwaschtische aus Keramik und Mineralguss runden dieses wunderschöne Badmöbelprogramm ab.

An absolute varying tile product line with classy visual appearance and exceptional design. The modern cabinet elements, able to be combined according to one's desires, along with mirrors with innovative LED technology (high degree of luminosity, low degree of power consumption) are perfectly coordinated for this. Variado displays structure with "Ranura!" These strong shaped surfaces in modern colouring contribute to a bathroom experience that emphasises feeling. For lovers of sleek visual appearance, the product line includes high polish white. Surface-mounted washbasins made of ceramic and cast mineral round off this beautiful bathroom furniture product line.

Un ensemble d'étagères entièrement modulable, d'un aspect visuel noble et avec un design insolite. Viennent en parfait accord avec celui-ci les éléments de rangement modernes, combinables à volonté, ainsi que le miroir fonctionnant avec la technologie innovante des LED (forte luminosité, faible consommation d'énergie). Variado, avec « Ranura » présente des éléments très structurés ! ces surfaces fortement marquées avec des coloris modernes contribuent à faire du bain un moment d'émotion. Pour les inconditionnels du tout simple, l'ensemble est également disponible en blanc brillant. Des lavabos en céramique et en fonte minérale viennent compléter ce magnifique ensemble de meubles de salle de bain.

Een zeer variabel assortiment wastafel bladen met een verfijnde afwerking en buitengewoon design. Perfect hierop afgestemd, zijn de moderne, naar keuze combineerbare kastelementen en de spiegels met innovatieve LED-techniek (hoge lichtsterkte, laag stroomverbruik). Variado brengt structuur met Ranura! Deze oppervlakken hebben een sterk reliëf in een moderne kleurstelling en zorgen voor extra emotie in de badkamer. Voor wie meer van glad houdt, is er de uitvoering in hoogglans wit. Opzetwastafels van keramiek en mineraalmarmer ronden dit prachtige assortiment badkamermeubelen af.







Frontfarben
Front finishes
Façades
Front kleuren

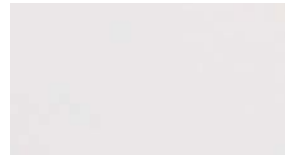

Polarweiß hgl.
polarwhite
blanc polaire
hoogglans wit

722



Nuss Dijon Ranura
walnut tree dijon ranura
noyer dijon ranura
donker noten dijon ranura

757



Hacienda Weiß Ranura
hacienda white ranura
blanc exotique ranura
hacienda wit ranura

758



Hacienda Schwarz Ranura
hacienda black ranura
noir exotique ranura
hacienda zwart ranura

759



Wenge Ranura
wenge ranura
wengé ranura
wengé ranura

760

Korpusfarben
Carcase
Corps de meuble
Corpus kleuren



Nussbaum Dijon
walnut tree dijon
noyer dijon
donker noten dijon

127



Hacienda Weiß
hacienda white
blanc exotique
hacienda wit

154



Hacienda Schwarz
hacienda black
noir exotique
hacienda zwart

155



Wenge
wenge
wengé
wengé

160

Waschtische
Washbasin
Vasques
Wastafel



Mineralguss Einbauwaschtisch, Weiß
Cast mineral surface-mounted washbasin, white
Vasque en matériau de synthèse, blanc
Opzetwastafel van mineraalmarmer, wit

1



Villeroy&Boch LOOP
Ovaler Aufsatzwaschtisch, Weiß
Oval surface-mounted washbasin, white
Vasque ovale, blanc
Opzetwastafel ovaal keramiek, wit

1



Villeroy&Boch LOOP
Rechteckiger Aufsatzwaschtisch, Weiß
Rectangular surface-mounted washbasin, white
Vasque rectangulaire, blanc
Opzetwastafel rechthoekig keramiek, wit

1



Swing

Neues Sehen und Fühlen.

Die neue Badmöbelgeneration von puris4life beweist nicht nur höchste Komfort-Klasse, sondern gibt den Takt durch ihr besonderes Design vor. Perfektion in der Qualität und Funktionalität, das Einsetzen von LED-Akzenten, moderne Frontdekore und die ergonomischen Formen geben hier den Ton an. So macht Swing erst richtig Spaß.

A new way of seeing and feeling.

The new generation of puris4life bath proves not only of highest comfort, but also calls the tune with its exclusive design. Perfection in terms of quality and function: integrated LED accents, modern wooden decors and ergonomic forms are important details. This is how swing was meant to be enjoyed.

Nouvelle présentation et nouvelle sensation.

La nouvelle génération de meubles de salles de bain puris4life bénéficie d'un confort très élevé et se différencie par son design particulier. Qualité parfaite, fonctionnalité par des éclairages LED, décors bois modernes et formes ergonomiques. Toutes ces particularités vous feront apprécier cette gamme.

Een nieuw design met een nieuwe vorm.

De nieuwe badmeubellijnen van puris4life bewijzen niet alleen dat ze een hoogwaardig comfort bieden, maar onderscheiden zich ook in vormgeving en design. Een combinatie van perfecte kwaliteit, ergonomische vormgeving en functionaliteit, het verwerken van LED verlichting en nieuwe moderne houtdecoren dat is waar swing voor staat.







Swing





Frontfarben
Front finishes
Façades
Front kleuren

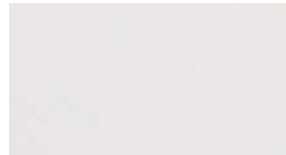

Polarweiß hgl. 722
polarwhite
blanc polaire
hoogglans wit



Hacienda Weiß 754
hacienda white
blanc exotique
hacienda wit



Hacienda Braun 756
hacienda brown
brun exotique
hacienda bruin



Hacienda Schwarz 755
hacienda black
noir exotique
hacienda zwart

Korpusfarben
Carcase
Corps de meuble
Corpus kleuren

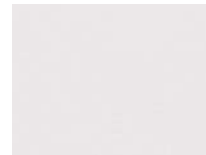

Weiß hgl. 105
highgloss white
blanc brillant
hoogglans wit



Hacienda Weiß 154
hacienda white
blanc exotique
hacienda wit



Hacienda Braun 156
hacienda brown
brun exotique
hacienda bruin



Hacienda Schwarz 155
hacienda black
noir exotique
hacienda zwart



Mineralguss-Farbe
Mineral washbasin colours
Couleur de matériau de synthèse
Minerale wastafel kleuren



Weiß 1
white
blanc
wit

Glaswaschtisch-Farben
Glass washbasin colours
Couleurs de vasques en verre
Glazen wastafel kleuren



Grün-Weiß 80
green-white
vert-blanc
groen-wit



Anthrazit 81
anthracite
anthracite
antraciet



Optiwhite 82
optiwhite
optiwhite
optiwit



Kera trends

Kera trends heißt die neu kreierte Badmöbelserie passend zu namhaften Keramikherstellern hochwertiger Waschtische. Kera trends besticht durch Gradlinigkeit und die damit verbundene puristische Erscheinung. Charakteristisch für Kera trends ist das Zusammenspiel von Design und Funktion, konsequent durchdacht und vollzogen bis ins kleinste Detail.

Kera trends means a new created bathroom furniture series matches high quality washstands from renowned ceramic manufacturers. Kera trends captivates with straight forms and the clear appearance. Characteristic of Kera trends is the combination from design and function, consequently shown and accomplished, up to the smallest detail.

Kera Trends est une nouvelle collection de meubles de salle de bains crée pour recevoir des vasques en céramique de haute qualité provenant de fabricants renommés. Les puristes seront séduits par l'association de matières par ses lignes droites et par le sens du détail.

Kera trends heet het nieuwe Puris badmeubelprogramma. De naam Kera trends sluit perfect aan bij de 3 A-producenten van hoogwaardige keramische wastafels waar wij mee werken. Kera trends onderscheidt zich door een moderne uitstraling gecombineerd met puristische vormen. Karakterestiek voor Kera trends is het samenspel van design en functionaliteit. Dit is zichtbaar in de consequent doordachte elementen en de onderscheiding tot in het kleinste detail.





Frontfarben
Front finishes
Façades
Front kleuren



Hacienda Weiß 754
hacienda white
blanc exotique
hacienda wit



Hacienda Braun 756
hacienda brown
brun exotique
hacienda bruin



Hacienda Schwarz 755
hacienda black
noir exotique
hacienda zwart



Nussbaum Dijon 737
walnut tree dijon
noyer dijon
donker noten dijon



Schokoeiche 724
choco oak
choco-chêne
schokoeiken

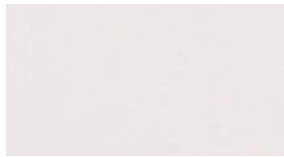

Polarweiß hgl. 722
polarwhite
blanc polaire
hoogglans wit



Titansilber hgl. 736
highgloss titan silver
argent-titane brillant
hoogglans titaan zilver



Anthrazit hgl. 686
highgloss anthracite
anthracite brillant
hoogglans antraciet



Saphirblau hgl. 752
sapphire blue
bleu saphir
safier hoogglans blauw



Carruba hgl. 753
carruba
caroube
carruba hoogglans bruin

Korpusfarben
Carcase
Corps de meuble
Corpus kleuren



Hacienda Weiß 154
hacienda white
blanc exotique
hacienda wit



Hacienda Braun 156
hacienda brown
brun exotique
hacienda bruin



Hacienda Schwarz 155
hacienda black
noir exotique
hacienda zwart

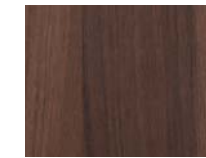

Nussbaum Dijon 127
walnut tree dijon
noyer dijon
donker noten dijon



Schokoeiche 119
choco oak
choco-chêne
schokoeiken



Weiß hgl. 105
highgloss white
blanc brillant
hoogglans wit



Titansilber hgl. 126
highgloss titan silver
argent-titane brillant
hoogglans titaan zilver



Anthrazit hgl. 121
highgloss anthracite
anthracite brillant
hoogglans antraciet

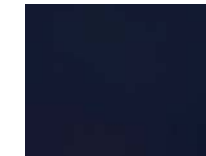

Saphirblau hgl. 152
sapphire blue
bleu saphir
safier hoogglans blauw

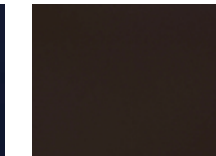

Carruba hgl. 153
carruba
caroube
carruba hoogglans bruin

Keramik-Waschtisch-Lösungen
Ceramic washstand solutions
Solutions de lavabos en céramique
Badmeubel met keramische wastafel



Renova Nr.1 Plan 550



Renova Nr.1 Plan 850 / 1000 / 1300 DWT



Subway 800 / 1000 / 1300 DWT



Sentique 800 / 1000 / 1300 DWT



Daylight 800 / 1000 / 1300 DWT



Cool line

Geradlinigkeit, reduziert auf das Wesentliche. Bestechend klare Formen kombiniert mit Dekorline-Design. Cool line vereint klassische Elemente mit dem Zeitgeist des 21. Jahrhunderts. Selbstbewusst und zugleich wohltuend schlicht setzt Cool line Akzente, zum Beispiel mit Design-Waschtischen aus Glas und hochwertigen Metallschubkästen mit Einzugsdämpfung. Cool line – und der Lebensraum Bad erscheint in einem neuen Licht.

Straightforwardness, reduced to the basics. Impressive clear forms combined with decorline-design. Cool line combines classical elements with the spirit of the 21st Century. Self-confident but at the same time genial, Cool line sets a course with the design glass washstands with high-quality metal drawers and a damped drawing-in of the drawer. Cool line – and the bathroom as a living space appears in a new light.

Cool Line est un meuble au design sobre. Par ses lignes épurées et ses vasques en verre, Cool Line associe l'esprit classique tout en s'orientant vers le 21^{ème} siècle. D'une finition de grande qualité, tiroirs métalliques avec freins et possibilité de personnaliser le meuble avec un liseré. Cool Line apparaîtra sous une nouvelle lumière.

Moderne vormen maken de toekomst. Een moderne vormgeving met een decorlijn. De serie Cool line combineert klassieke accenten met moderne vormen uit de 21e eeuw. Zelfbewust en tegelijk een verfrissende vormgeving, met bijvoorbeeld design glazen wastafels en hoogwaardige zelfsluitende lades met demping. Cool line – en de Badkamer straalt in een nieuw licht.







Cool
line



Metallauszug mit Silent-System und gedämpftem Selbststeizug
 Optional: Auszugseinteilung inkl. Befestigungsstange

Metal drawer: Fully extendable, closes softly and quietly
 with Silent-System damping
 Option: Adjustable organizer components

Couissant métallique avec système Silent et autoentrée avec frein. Op-
 tion: aménagement tiroir avec barre de fixation.

2 metalen zelfsluitende lades met vakverdeling
 Optie: Ladenindeling incl. bevestigingsstang



Glas-Doppelwaschtisch
im Farbton Optiwhite

Glass Double Sink
in optiwhite

Double vasque en verre,
couleur optiwhite

Dubbele glazen wastafel
in de kleur optiwit



Cool
line



Dekorline Zwischenplatte

Dekorline board
Liseré décoratif
Decor blad

	154		105
Hacienda Weiß hacienda white blanc exotique hacienda wit		Weiß hgl. highgloss white blanc brillant hoogglans wit	
	156		129
Hacienda Braun hacienda brown brun exotique hacienda bruin		Chrom hgl. chrome chromé hoogglans chrom	
	155		126
Hacienda Schwarz hacienda black noir exotique hacienda zwart		Titansilber hgl. highgloss titan silver argent-titane brillant hoogglans titaan Zilver	
	118		128
Nussbaum walnut tree noyer noten		Mintgrün hgl. light green vert-menthe hoogglans mint groen	
	127		122
Nussbaum Dijon walnut tree dijon noyer dijon donker noten dijon		Cappuccino hgl. cappuccino cappuccino hoogglans cappuccino	
	119		124
Schokoeiche choco oak choco-chêne schokoekien		Orange hgl. orange orange hoogglans oranje	
	153		123
Carruba hgl. carruba caroube hoogglans carruba bruin		Brillantröt hgl. red brillant rouge brillant hoogglans rood	
	121		152
Anthrazit hgl. highgloss anthracite anthracite brillant hoogglans antraciet		Saphirblau hgl. sapphire blue bleu saphir hoogglans safier blauw	

Glaswaschtisch-Farben

Glass washbasin colours
Couleurs de vasques en verre
Glazen wastafel kleuren

	Grün-Weiß green-withe vert-blanc groen-wit	80
	Anthrazit anthracite anthracite antraciet	81
	Optiwhite optiwhite optiwhite optiwit	82

Mineralguss-Farbe

Mineral washbasin colours
Couleur de matériau de synthèse
Minerale wastafel kleuren











	Weiß white blanc wit	1
--	-------------------------------	---

Lavandino-Farbe





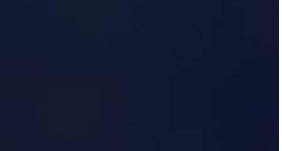
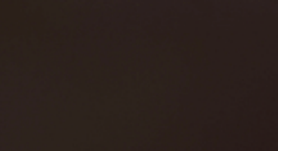



Lavandino-colour
Couleur de vasque lavandino
Lavandino wastafelkleuren

	Multicolor Weiß multicolour white multicolor blanc multicolor wit	58
--	--	----

Frontfarben
Front finishes
Façades
Front kleuren

					
Hacienda Weiß hacienda white blanc exotique hacienda wit	754 Hacienda Braun hacienda brown brun exotique hacienda bruin	756 Hacienda Schwarz hacienda black noir exotique hacienda zwart	755 Edelnusbaum noble walnut tree noyer noble noten	723 Nussbaum Dijon walnut tree dijon noyer dijon donker noten dijon	737 Schokoeiche choco oak choco-chêne schokoeiken
					
722 Polarweiß hgl. polarwhite blanc polaire hoogglans wit	736 Titansilber hgl. highgloss titan silver argent-titane brillant hoogglans titaan zilver	686 Anthrazit hgl. highgloss anthracite anthracite brillant hoogglans antraciet	752 Saphirblau hgl. sapphire blue bleu saphir safier hoogglans blauw	753 Carruba hgl. carruba caroube carruba hoogglans bruin	725 Brillantrot hgl. red brillant rouge brillant hoogglans rood

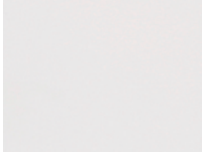
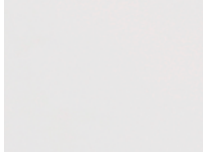
Korpusfarben
Carcase
Corps de meuble
Corpus kleuren

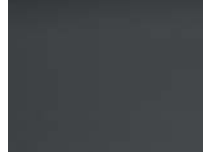
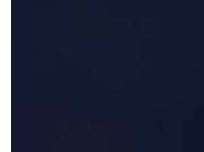
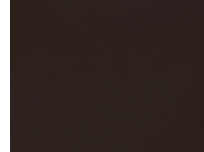
					
Hacienda Weiß hacienda white blanc exotique hacienda wit	154 Hacienda Braun hacienda brown brun exotique hacienda bruin	156 Hacienda Schwarz hacienda black noir exotique hacienda zwart	118 Nussbaum walnut tree noyer noten	127 Nussbaum Dijon walnut tree dijon noyer dijon donker noten dijon	119 Schoko choco choco schoko
					
101 Weiß white blanc wit	105 Weiß hgl. highgloss white blanc brillant hoogglans wit	126 Titansilber hgl. highgloss titan silver argent-titane brillant hoogglans titaan zilver	121 Anthrazit hgl. highgloss anthracite anthracite brillant hoogglans antraciet	152 Saphirblau hgl. sapphire blue bleu saphir safier hoogglans blauw	153 Carruba hgl. carruba caroube carruba hoogglans bruin



elegance

Der Dreiklang aus Form, Individualität und Funktion.
Programm Elegance - Außen pure Ästhetik, innen perfekte Bad-Innovation.
Die gelungene Verbindung von Design und Funktionalität sind die persönliche Visitenkarte individueller Badkultur.

The triad of form, individualism and function.
Elegance range - pure aesthetics on the outside, perfect bathroom innovation in the inside. The successful combination of design and functionality are the personal calling card of an individual bathroom culture.

L'harmonie des formes et de la fonctionnalité.
Le programme ELEGANCE propose une esthétique pure tout en innovant.
La relation réussie de la conception et du côté fonctionnel affirme le caractère de cette collection. L'élégance à l'état pur.

Het samenvoegen van vorm, individualiteit en functionaliteit.
Dat is wat het programma elegance u biedt. Van buiten pure klasse, van binnen een perfecte innovatie. Een geslaagde samensmelting van design en functionaliteit met een geslaagde persoonlijke uitstraling. De serie elegance biedt u dit alles.







elegance



Frontfarben
Front finishes
Façades
Front kleuren



Hacienda Weiß 754
hacienda white
blanc exotique
hacienda wit



Hacienda Braun 756
hacienda brown
brun exotique
hacienda bruin



Hacienda Schwarz 755
hacienda black
noir exotique
hacienda zwart



Nussbaum Dijon 737
walnut tree dijon
noyer dijon
donker noten dijon



Edelnussbaum 723
noble walnut tree
noyer noble
noten



Cappuccino hgl. 728
cappuccino
cappuccino
cappuccino

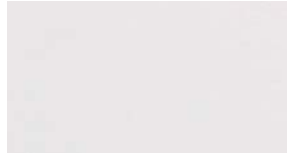

Polarweiß hgl. 722
polarwhite
blanc polaire
hoogglans wit



Titansilber hgl. 736
highgloss titan silver
argent-titane brillant
hoogglans titaan zilver



Anthrazit hgl. 686
highgloss anthracite
anthracite brillant
hoogglans antraciet



Saphirblau hgl. 752
sapphire blue
bleu saphir
safier hoogglans blauw



Carruba hgl. 753
carruba
caroube
carruba hoogglans bruin



Brillantrot hgl. 725
red brillant
rouge brillant
hoogglans rood

Korpusfarben
Carcase
Corps de meuble
Corpus kleuren



Hacienda Weiß 154
hacienda white
blanc exotique
hacienda wit



Hacienda Braun 156
hacienda brown
brun exotique
hacienda bruin



Hacienda Schwarz 155
hacienda black
noir exotique
hacienda zwart



Nussbaum 118
walnut tree
noyer
noten



Nussbaum Dijon 127
walnut tree dijon
noyer dijon
donker noten dijon



Schoko 119
choco
choco
schoko



Ahorn 115
maple
érable
ahorn

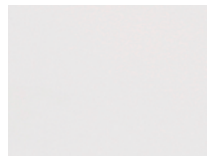

Weiß 101
white
blanc
wit

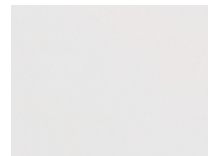

Weiß hgl. 105
highgloss white
blanc brillant
hoogglans wit



Titansilber hgl. 126
highgloss titan silver
argent-titane brillant
hoogglans titaan zilver



Anthrazit hgl. 121
highgloss anthracite
anthracite brillant
hoogglans antraciet



Saphirblau hgl. 152
sapphire blue
bleu saphir
safier hoogglans blauw

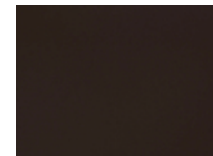

Carruba hgl. 153
carruba
caroube
carruba hoogglans bruin

Waschtischfarben
Washbasin colours
Couleurs de vasque
Wastafel kleuren



Mineralguss
Weiß 1
white
blanc
wit



Lavandino
Multicolor Weiß 58
multicolour white
multicolor blanc
multicolor wit



Glas
Anthrazit 81
anthracite
anthracite
antraciet



Glas
Optiwhite 82
optiwhite
optiwhite
optiwit

Griffe
Handles
Poignées au choix
Grepfen



Stangengriff Chrom 283
handle chrome
poignée chrome
stangengreep chrom



Stangengriff Chrom 290
handle chrome
poignée barre chrome
stangengreep chrom

elegance

Planungsbeispiele
 Planning examples
 Exemples
 Sets

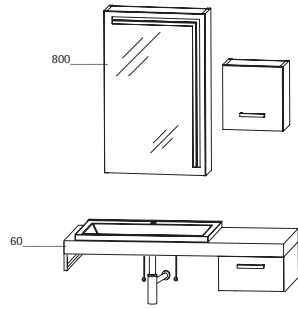

VAM-0160-1

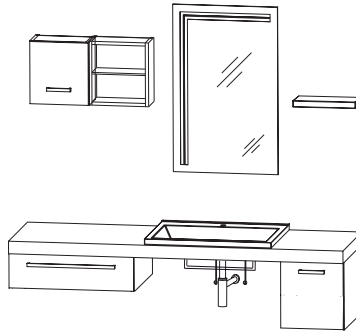

VAM-0160-2

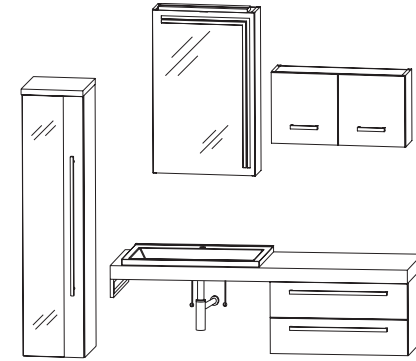

VAM-0160-3

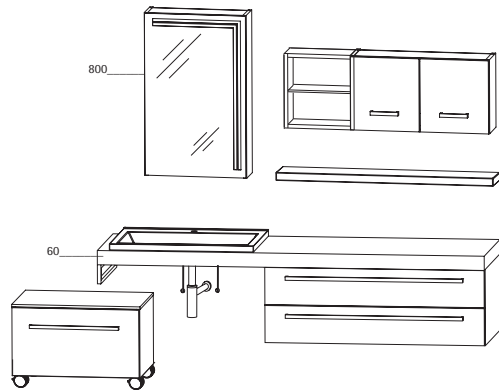

VAM-0160-4

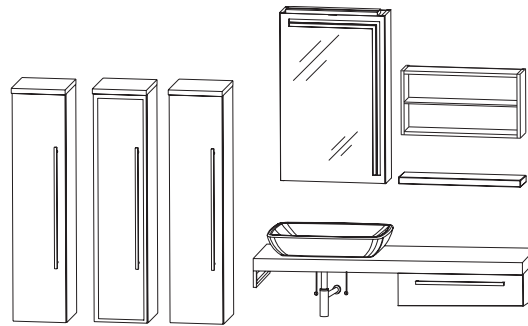

VAK-L260-5

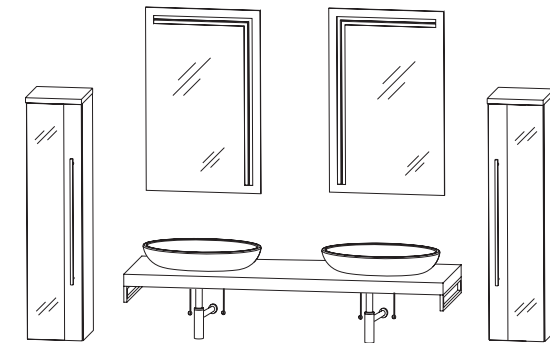

VAK-L160-6

Ergänzungsschränke
Additional cabinets
Meubles complémentaires
Losse kasten



RTA-256A-1
600 x 336



RTA-259A-1
900 x 336



RTA-276A-1
600 x 336

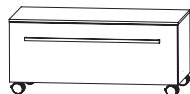

RTA-279A-1
900 x 336



SBF-1503-38
300



SBF-1506-38
600



SBF-1509-38
900



MNA-813A
300 x 1296

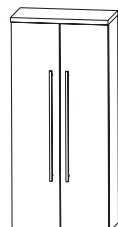

MNA-816A
600 x 1296



MNA-813B
300 x 1296



MNA-816B
600 x 1296

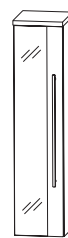

MNA-813A-G
300 x 1296

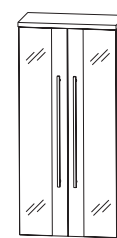

MNA-816A-G
600 x 1296



OGA-2130-1
300 x 320

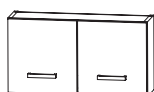

OGA-2160-1
600 x 320



RG-2130-1
300 x 320



RG-2160-1
600 x 320



UNA-213 A
300 x 336

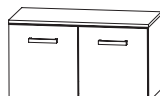

UNA-216 A
600 x 336



UNA-253 A
300 x 336



UNA-256 A
600 x 336



UNA-273 A
300 x 336



UNA-276 A
600 x 336

Türen / Auszüge / Schubkästen mit Dämpfung
Doors / pull out units / drawers with buffered closing
Portes battantes / tiroirs / rayons avec silent-system
Deuren / hoge zelfsluitende lade / zelfsluitende lade

Breite x Höhe in mm
Width x height in mm
Largeur x hauteur en mm
Breedte x hoogte in mm

Detailaufnahmen
Details
Détails
Details



Badvariationen
 Planning proposals
 Exemples de composition
 Sets

Ergänzungsschränke
 Additional cabinets
 Meubles complémentaires
 Losse kasten

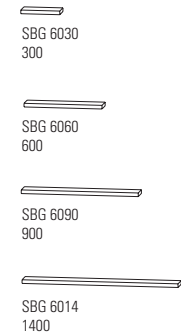
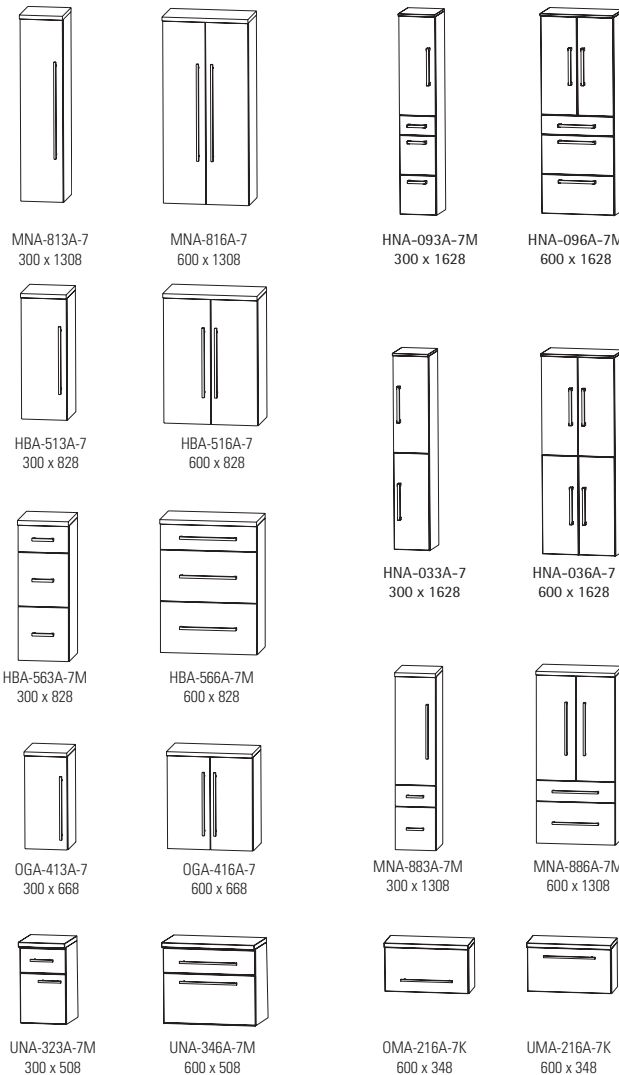
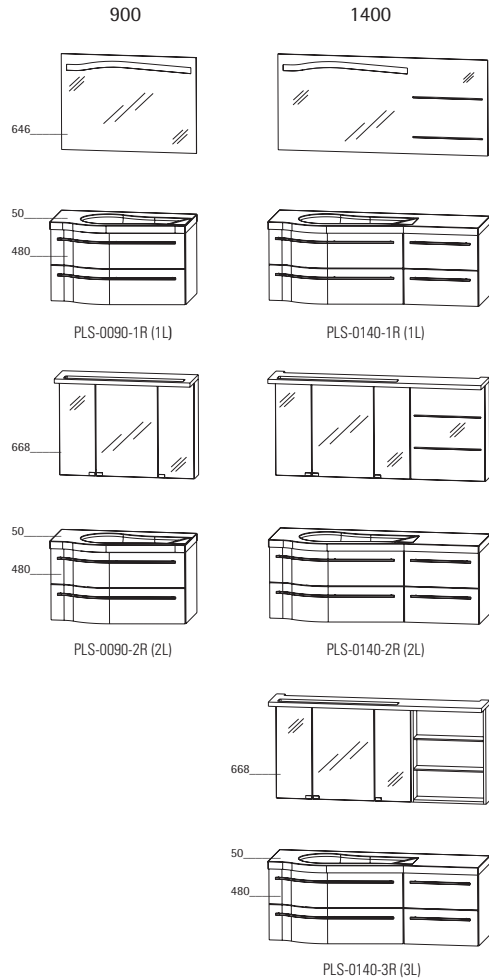

Türen / Auszüge / Schubkästen mit Dämpfung
 Doors / pull out units / drawers with buffered closing
 Portes battantes / tiroirs / rayons avec silent-system
 Deuren / hoge zelfsluitende lade / zelfsluitende lade

Breite x Höhe in mm
 Width x height in mm
 Largeur x hauteur en mm
 Breedte x hoogte in mm

Abbildungen mit Mineralguss-WT, auch mit Glas erhältlich.
 Drawing with mineral washbasin, also glass possible.
 Exemples de composition avec vasque en matériau de synthèse
 sont possible aussi vasque de verre.
 Afbeeldingen met mineralguss wastafels een glazen wastafels
 is ook mogelijk.

Swing



KERAMAG
 Renova Nr. 1 Plan 550



KERAMAG
 Renova Nr. 1 Plan 850/1000/1300 DWT

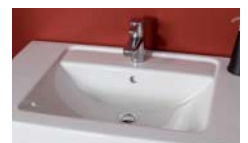

Villeroy & Boch
 1748
 Subway 800 / 1000 / 1300 DWT



Villeroy & Boch
 1748
 Sentique 800 / 1000 / 1300 DWT



Ideal Standard
 Daylight 800 / 1000 / 1300 DWT

Keramik-Waschtisch-Lösungen

Ceramic washstand solutions – Choix de vasque en céramique – Sets met keramische wastafels



Ergänzungsschränke

Additional cabinets – Meubles complémentaires – Losse kasten

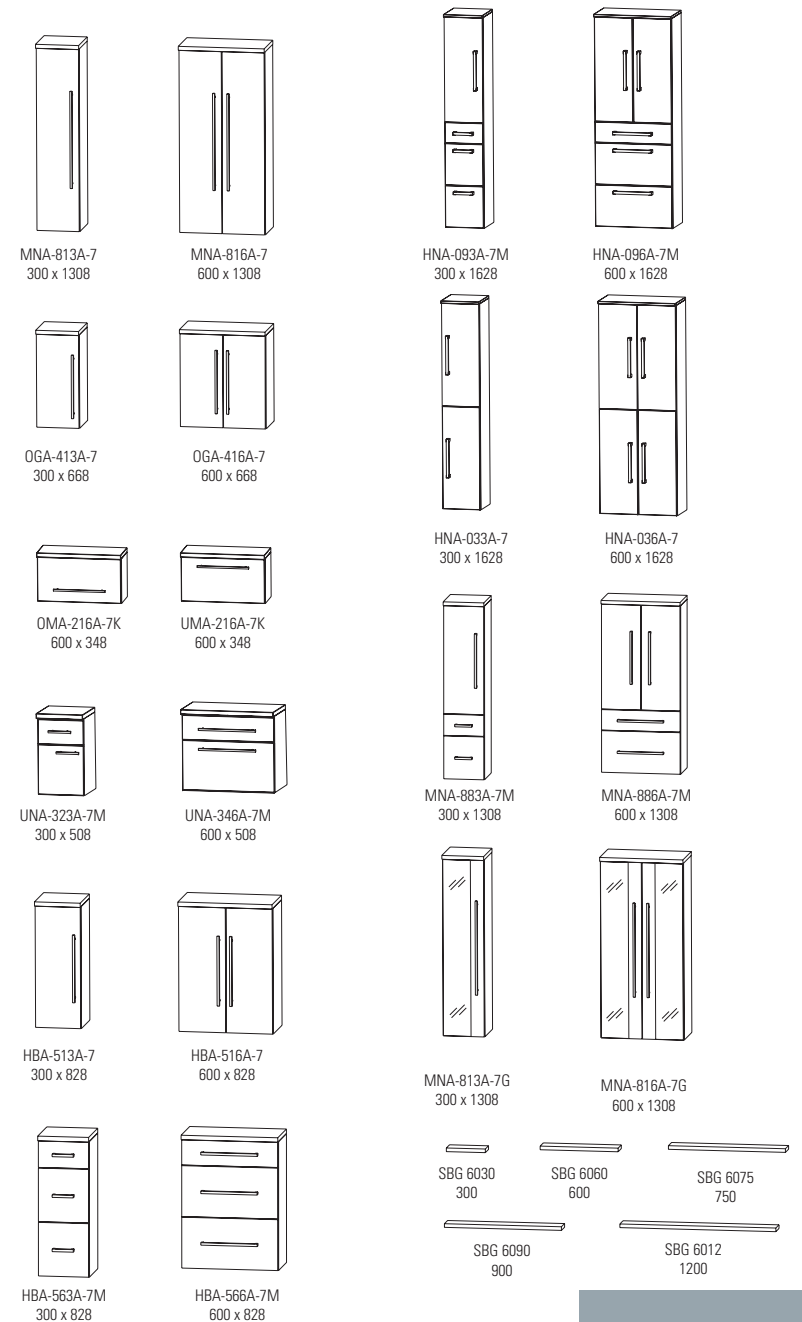

Badvariationen
 Planning proposals
 Exemples de composition
 Sets

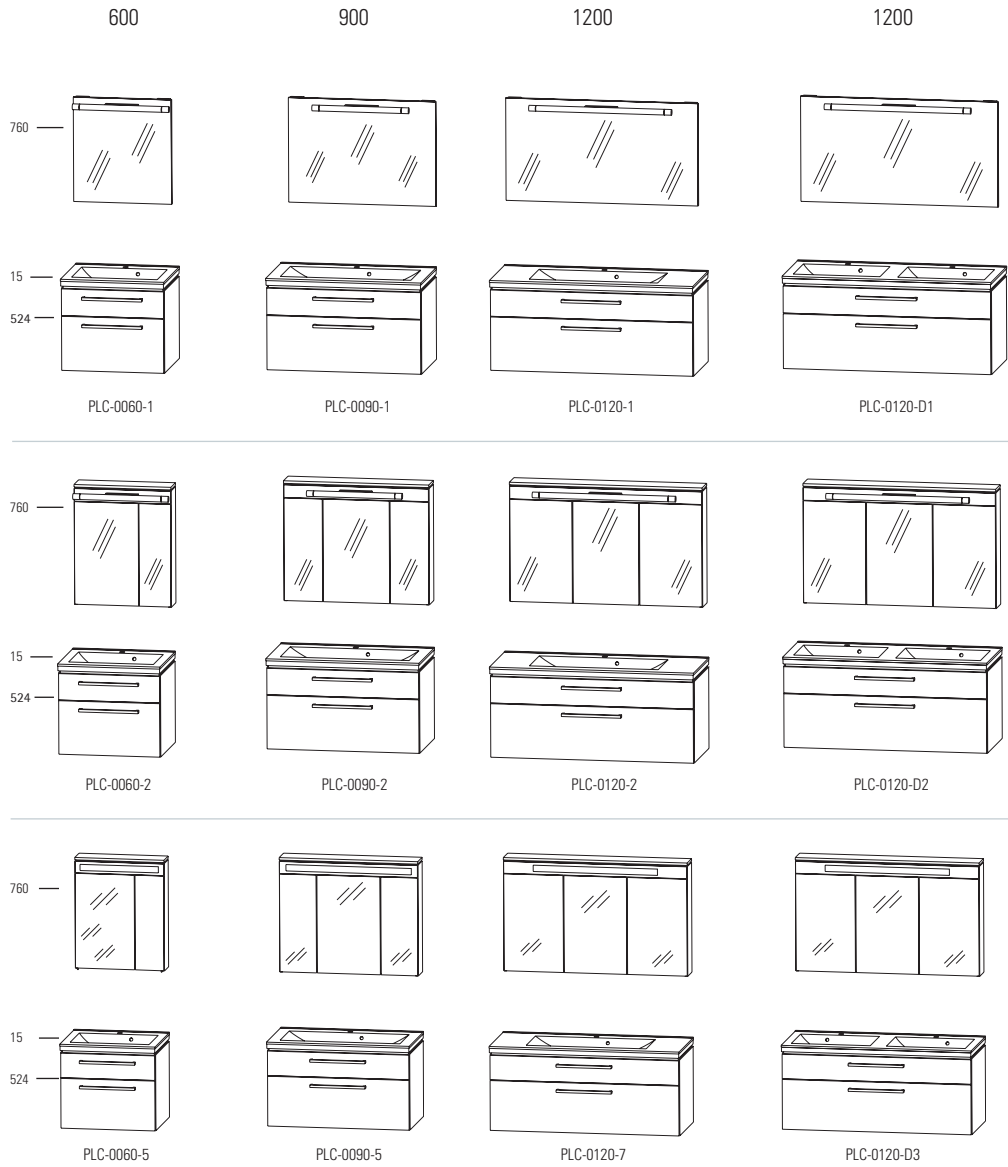

Ergänzungsschränke
 Additional cabinets
 Meubles complémentaires
 Losse kasten

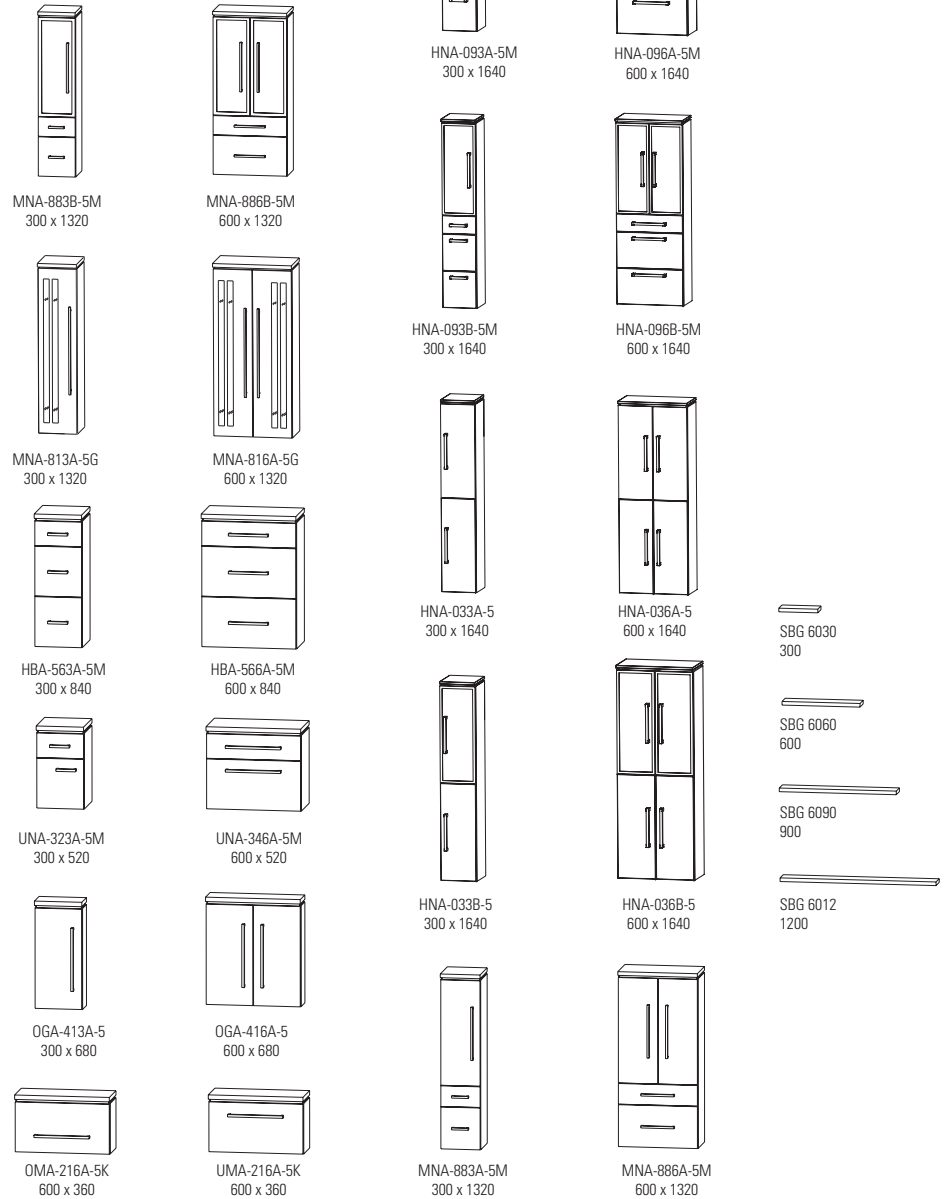

Abbildungen mit Mineralguss-WT, auch mit Glas oder Lavandino erhältlich.
 Drawing with mineral washbasin, also glass or lavandino possible.
 Exemples de composition avec vasque en matériau de synthèse sont possible aussi vasque de verre ou vasque de lavandino.
 Afbeeldingen met mineralguss wastafels een glazen wastafels of lavandino wastafels is ook mogelijk.

Badvariationen
 Planning proposals
 Exemples de composition
 Sets

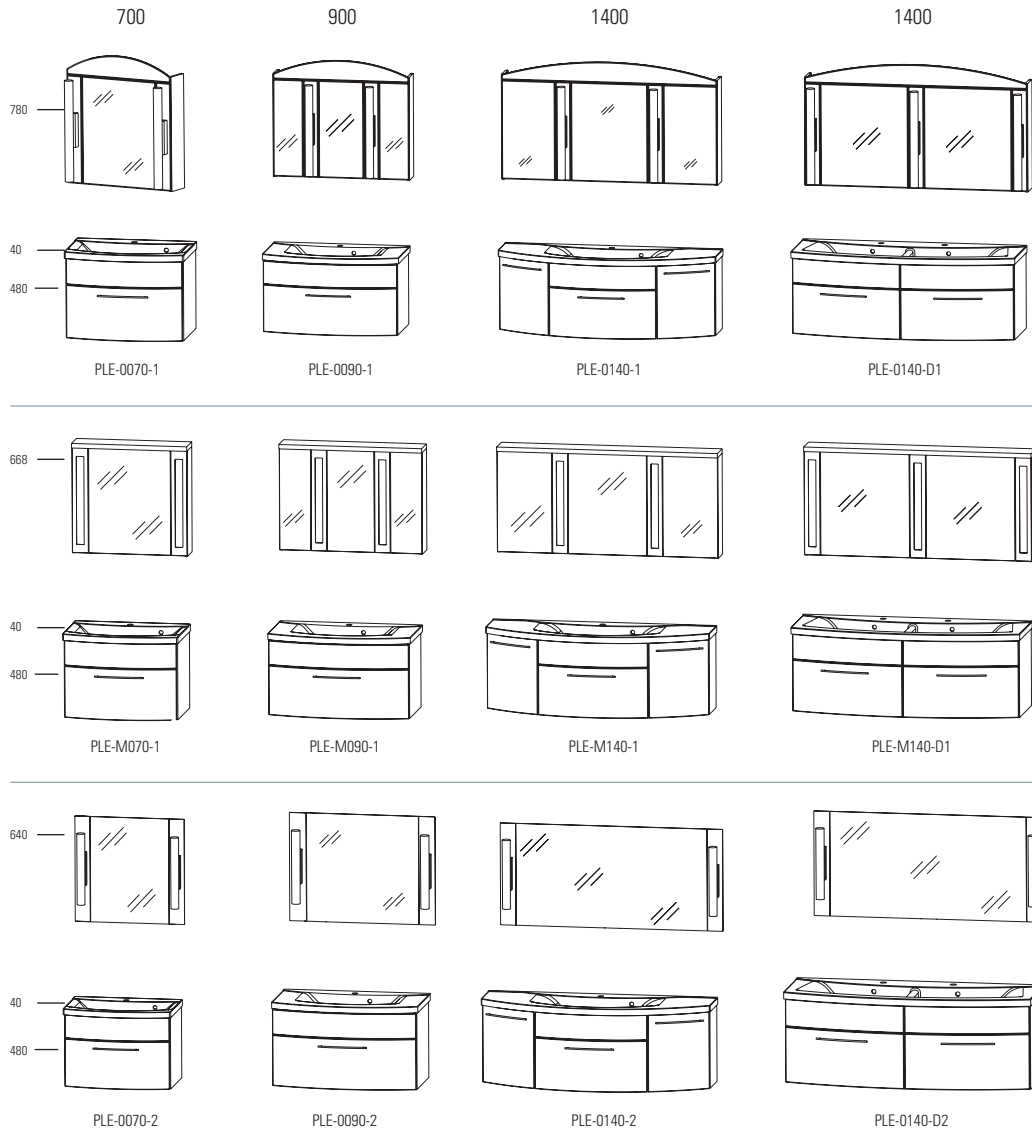

Ergänzungsschränke
 Additional cabinets
 Meubles complémentaires
 Losse kasten

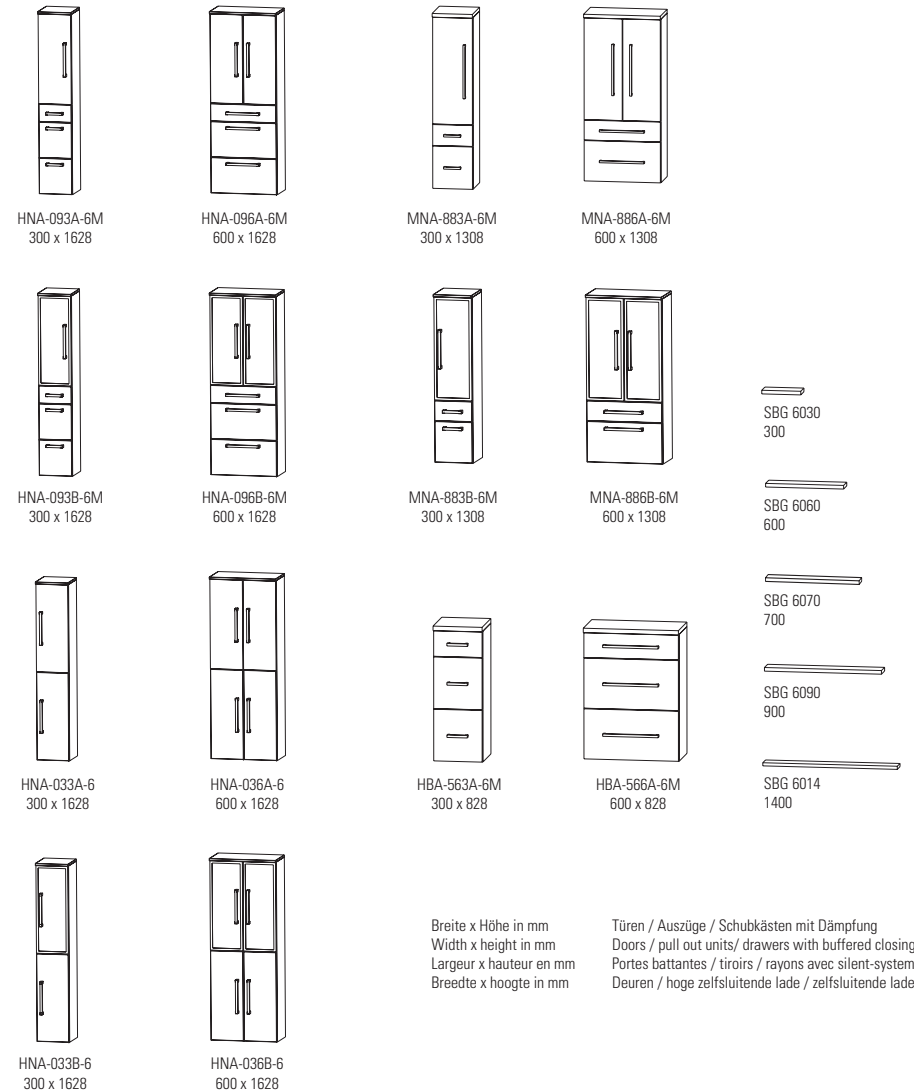

Breite x Höhe in mm
 Width x height in mm
 Largeur x hauteur en mm
 Breedte x hoogte in mm

Türen / Auszüge / Schubkästen mit Dämpfung
 Doors / pull out units / drawers with buffered closing
 Portes battantes / tiroirs / rayons avec silent-system
 Deuren / hoge zelfsluitende lade / zelfsluitende lade

Abbildungen mit Mineralguss-WT, auch mit Glas oder Lavandino erhältlich.
 Drawing with mineral washbasin, also glass or lavandino possible.
 Exemples de composition avec vasque en matériau de synthèse sont possible aussi vasque de verre ou vasque de lavandino.
 Afbeeldingen met mineralguss wastafels een glazen wastafels of lavandino wastafels is ook mogelijk.

elegance

puris4life
spirit of bathrooms

puris Bad GmbH
Hinterm Gallberg
D-59929 Brilon
mail@puris.de
www.puris.de

ABBILDUNGEN UND ANGABEN SIND UNVERBINDLICH. TECHNISCHE ÄNDERUNGEN VORBEHALTEN.
ILLUSTRATIONS AND SPECIFICATIONS ARE WITHOUT OBLIGATION. TECHNICAL MODIFICATIONS RESERVED
REPRODUCTIONS ET DONNÉES TECHNIQUES SANS ENGAGEMENT DE NOTRE PART.
SOUS RÉSERVE DE MODIFICATIONS TECHNIQUES.
AFBEELDINGEN EN SPECIFICATIES VRIJBLIJVEND. TECHNISCHE WIJZIGINGEN VOORBEHOUDEN.